

For Air

Full-Blow Cupla

Low pressure loss & high flow rate

Working pressure



1.5 MPa
(15 kgf/cm²)

Valve structure



One-way shut-off

Applicable fluid



Air



Push-to-connect operation can be made with no line pressure

Built-in sleeve lock mechanism

Purge function eliminates unpleasant pop and hose whipping motion

Unique full-open gate type valve

While the plug and socket are connected, valve can be opened or closed

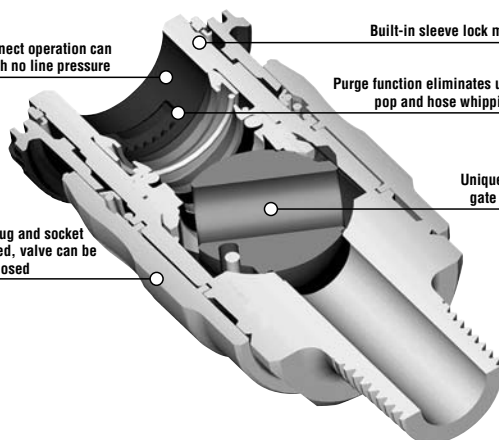

Unique full-open gate type valve mechanism realizes low pressure loss and high flow rate, which reduces required source air volume.

- The flow rate is increased by up to 40% more than that of conventional Cuplas.
 - During connection and disconnection, the valve is closed, enabling connection/disconnection under zero line pressure.
 - When the sleeve of socket is returned to the original position, the purge mechanism releases the residual pressure inside the plug eliminating unpleasant pop and hose whipping motion.
 - Built-in sleeve lock mechanism prevents unexpected disconnection of Cuplas, assuring safe operation.
 - The valve can be opened and closed while the socket and plug is connected.
 - The weight is reduced by 30 to 45% compared with that of conventional Cuplas.
- Note: Direct mounting of Full-Blow Cupla to percussive and vibrating tools should be avoided.

Specifications

Body material	Aluminum alloy			
Size	1/4" (20 type) • 3/8" (30 type) • 1/2" (40 type)			
	For ø6.5 mm x ø10 mm • ø8 mm x ø12 mm polyurethane hose For ø8.5 mm x ø12.5 mm • ø11 mm x ø16 mm polyurethane hose			
Working pressure MPa (kgf/cm ²)	1.5 (15)			
Pressure resistance MPa (kgf/cm ²)	2.0 (20)			
Seal material	Nitrile rubber	NBR (SG)	Working temperature range	-5°C~+60°C
Working temperature range	Standard material			

Max. Tightening Torque

N·m (kgf·cm)

Size	1/4"	3/8"	1/2"	spring nut
Torque	14 (143)	22 (224)	66 (612)	9~11 (92~112)

Flow Direction

Fluid must run from socket to plug.

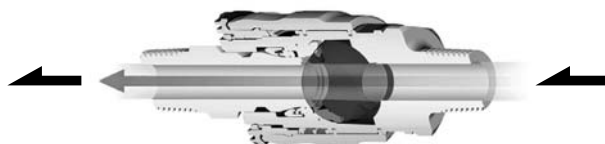

Interchangeability

Can be connected with plugs from Hi Cupla Models 20, 30 and 40. Interchangeable with each corresponding Hi Cupla Series models.

Min. Cross-Sectional Area

(mm²)

Model	17PH	20PH	20PM/PF	30PH	30PM/PF	40PH	40PM/PF
FBH-20SH	16	20	23.8	23.8	23.8	23.8	23.8
FBH-30SH	16	20	44.2	44.2	44.2	44.2	44.2
FBH-40SH	16	20	44.2	44.2	44.2	44.2	44.2
FBH-20SM	16	20	44.2	44.2	44.2	44.2	44.2
FBH-30SM	16	20	44.2	44.2	44.2	44.2	44.2
FBH-40SM	16	20	44.2	44.2	44.2	44.2	44.2
FBH-20SF	16	20	44.2	44.2	44.2	44.2	44.2
FBH-30SF	16	20	44.2	44.2	44.2	44.2	44.2
FBH-40SF	16	20	44.2	44.2	44.2	44.2	44.2
FBH-65SN	16	20	23.8	23.8	23.8	23.8	23.8
FBH-80SN	16	20	44.2	44.2	44.2	44.2	44.2
FBH-85SN	16	20	44.2	44.2	44.2	44.2	44.2
FBH-110SN	16	20	44.2	44.2	44.2	44.2	44.2

Suitability for Vacuum

Not suitable for vacuum application in either connected or disconnected condition.

Pressure - Flow Rated Characteristics (Comparison with Hi Cupla)

[Test conditions] • Fluid : Air • Temperature : Room temperature

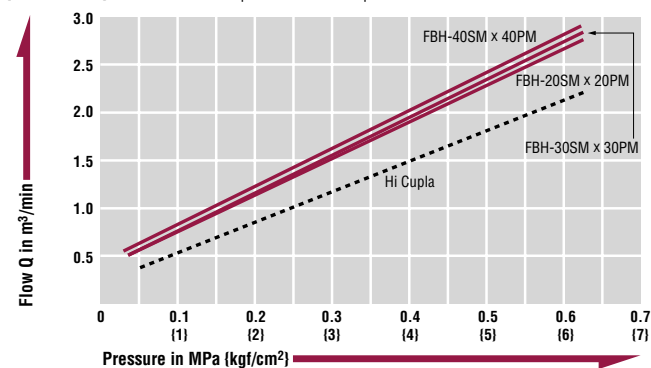

Models and Dimensions

WAF : WAF stands for width across flats.

Socket SH type (Hose barb)

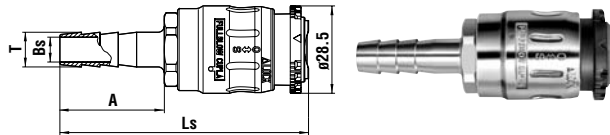

Model	Application (Hose)	Mass (g)	Dimensions (mm)			
			Ls	A	øT	øBs
FBH-20SH	1/4"	70	77	30	9	5.5
FBH-30SH	3/8"	74	81	34	11.3	8
FBH-40SH	1/2"	85	83	36	15	10

Socket SM type (Male thread)

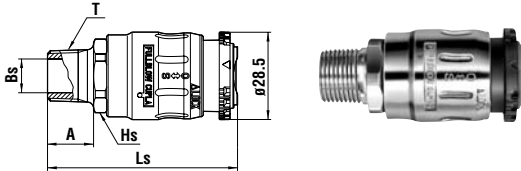

Model	Application	Mass (g)	Dimensions (mm)				
			Ls	Hs(WAF)	A	T	øBs
FBH-20SM	Rc 1/4	71	62	Hex.22	15	R 1/4	8
FBH-30SM	Rc 3/8	75	62	Hex.22	15	R 3/8	11
FBH-40SM	Rc 1/2	86	66	Hex.22	19	R 1/2	15

Socket SF type (Female thread)

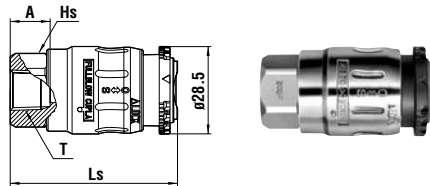

Model	Application	Mass (g)	Dimensions (mm)			
			Ls	Hs(WAF)	A	T
FBH-20SF	R 1/4	77	54.5	Hex.22	13	Rc 1/4
FBH-30SF	R 3/8	69	54.5	Hex.22	13	Rc 3/8
FBH-40SF	R 1/2	90	61	Hex.26	17	Rc 1/2

Socket SN type (For urethane hose with spring nut connection)

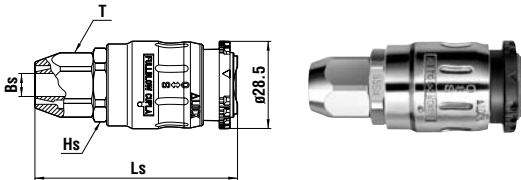

Model	Application (Hose)	Mass (g)	Dimensions (mm)			
			Ls	Hs(WAF)	T(WAF)	øBs
FBH-6SSN	ø6.5 mm x ø10 mm	64	64	Hex.22	Hex.17	5.5
FBH-80SN	ø8 mm x ø12 mm	67	66	Hex.22	Hex.19	7.5
FBH-85SN	ø8.5 mm x ø12.5 mm	68	66	Hex.22	Hex.19	7.5
FBH-110SN	ø11 mm x ø16 mm	86	71	Hex.26	Hex.24	10

How it works

1. Open the valve

Only after connection with the plug, you can slide the socket sleeve B toward the plug in order to open the built-in valve. Full flow path is then obtained.

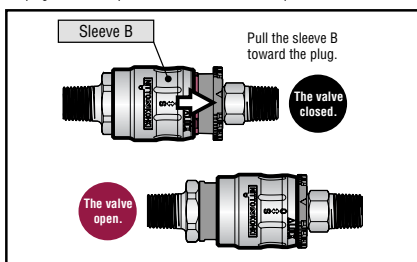

2. Lock the sleeve

Rotate the flange to lock the sleeve B. Without unlocking the plug you cannot disconnect.

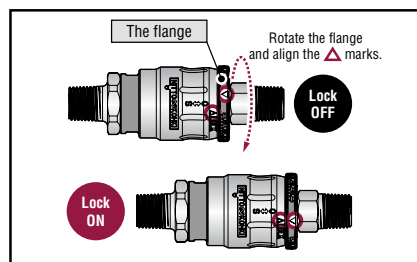

3. Purge the residual air

To disconnect the plug, first turn the flange back to the original position for unlocking and then pull the sleeve B back to the original position. The built-in valve will be closed to purge the residual air pressure.

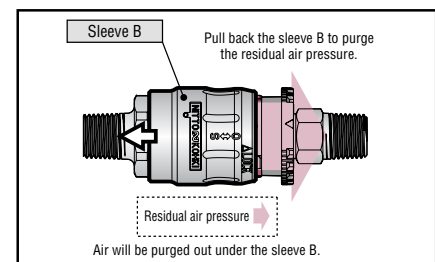

Features of Full-Blow Cupla

Up to about 40% increase in flow rate.

Pressure loss is reduced to the ultimate level. Up to about 40% increase in flow rate compared with conventional Cuplas.

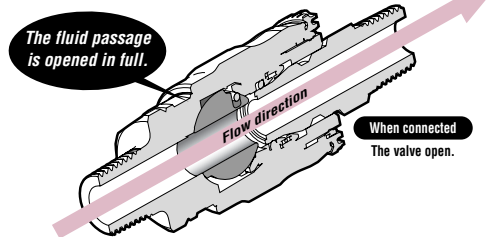
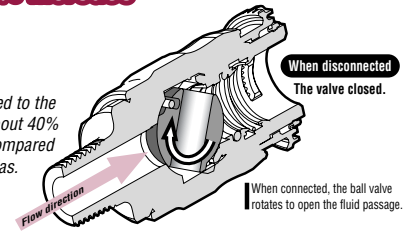

Energy saving effect

If conventional Cuplas are replaced by Full-Blow Cuplas, pressure loss in the air lines can be reduced. Thanks to this, the source pressure at the outlet port of the compressor can be saved.

Note: Energy saving effect depends on the conditions of air piping and the compressor.

For instance

